

300 STILE
S/A D300 FOR OFFSET
PIVOTS/BUTT HINGE

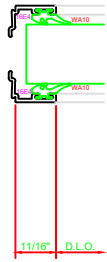

305 STILE
S/A D300 FOR OFFSET
PIVOT/BUTT HINGE

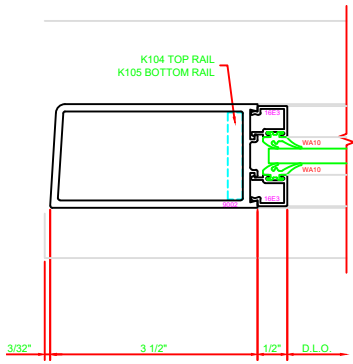
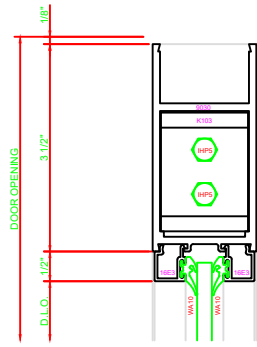
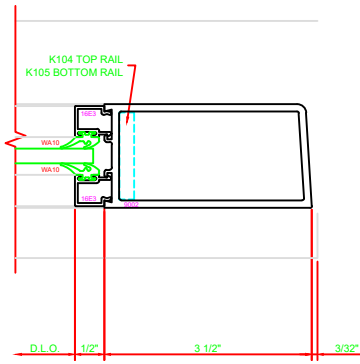

100 TOP RAIL
S/A D300

ERASE NOTE:
TOP RAIL FOR SURFACE CLOSERS OR
DORMA TYPE C.C.C., NOT LCN C.C.C.

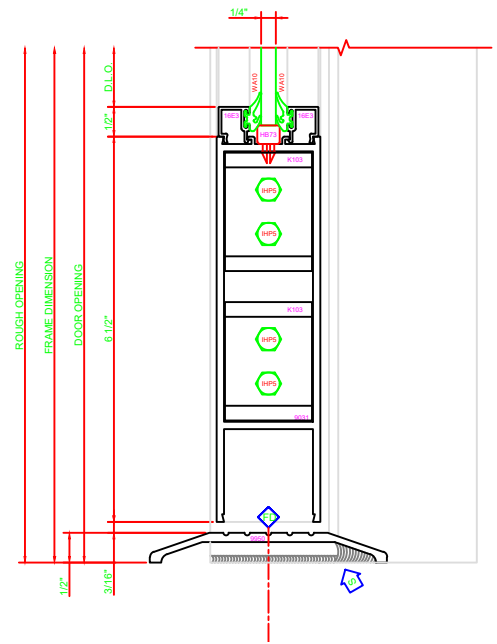
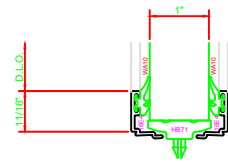
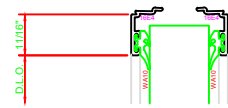

200 BOTTOM RAIL
S/A D300